

## **Diminishing DC link voltage variation in DVR using load current feed forward**

Sajitha Andrews, Subash Joshi T. G

<sup>1</sup>(Power electronics group, CDAC Trivandrum, India)

<sup>2</sup>(Power electronics group, CDAC Trivandrum, India)

---

**Abstract:** For voltage sensitive industrial applications a momentary disturbance in grid voltage interrupts the production line. Dynamic voltage restorer is used as a solution to ride through such conditions. The paper presents a DVR with fast and accurate dynamic response. The operation and performance of DVR is highly influenced by the control algorithm implemented. The paper presents control architecture for DVR using Proportional Resonant controller. DVR topology with an active shunt converter connected to load side is used in this paper. DC link voltage variation during sudden load changes and sag/swell occurrences is diminished by an active current feed forward algorithm using moving average filter. The performance is verified experimentally at field trial in a textile mill with numerous non-linear loads and sophisticated electronic equipment which are sensitive to the quality of power.

**Keywords:** Active current, Dynamic Voltage Restorer, Moving Average Filter, PR controller

---

### **I. Introduction**

Ideally grid voltage should be a pure sinusoid of required magnitude and frequency. But in reality there may be distortions from these conditions which cause adverse effects on connected load. The impact of this disturbance causes minimum financial loss to residential customers. But power quality issues cause significant problems to industrial customers as there might be critical loads which will be shut down due to this disruption in voltage quality. A brief interruption in voltage in an industry will cause heavy financial loss due to stoppage of continuous processes. One method to improve supply voltage quality is by installation of series custom power device called Dynamic Voltage Restorer (DVR). DVR can avoid tripping and loss of production due to voltage sag/swell occurrences [1]. The Dynamic Voltage Restorer (DVR) has a series compensator and shunt converter. Series compensator is connected in series with the grid using an injection transformer and the shunt converter maintains the DC bus. Series compensator mitigates the PQ issues related to voltages, whereas shunt converter provides a bidirectional path for power flow and also provides DC voltage required for the proper operation of series compensator. The voltage at the Point of Common Coupling (PCC) [2] is measured and used for voltage sag detection. In the event of sag occurrence DVR injects voltage into the utility grid, thereby preventing the critical loads from tripping. During the injection mode DVR exchanges active and reactive power with the grid. There are different DVR topologies depending on how the active power is supplied [3]. Broadly DVR can be classified into two types of systems, one using stored energy to supply the delivered power and the other having no significant internal energy storage. In this paper DVR with an active shunt converter is considered. The shunt converter minimizes the requirement of internal energy storage. Energy supplied by the converter is drawn instantaneously from the load side of the utility grid. One disadvantage of this type of system is that the current drawn from grid during sag conditions will be more. The necessary power to the load is readily available by feed forwarding the dc equivalent of active component of DVR currents. In this paper a moving average filter is used to extract the active component from instantaneous values of three phase DVR currents. Feed-forwarding the active component helps to maintain the DC link at a constant voltage even during a sudden switching on of full load.

### **II. DVR Topology**

The DVR consists of a shunt and three series converters connected back to back through common dc bus capacitors. The configuration is characterized by connecting the shunt converter to the load side. A LC filter is used to eliminate the switching frequency ripple in the series inverter output voltage. The low pass filter corner frequency is chosen such that almost all of the high frequency harmonics due to switching is eliminated from the inverter voltage and the injected voltage remains sinusoidal. The injection transformer is a step up transformer such that the DC bus and the device voltage requirements are reduced. The shunt converter is connected to the load side of utility grid using synchronous impedance and a step down transformer [5]. It should be noted that when using the DVR in real situations, the injection transformer will be connected in parallel with a bypass switch. When the DVR operation needs to be bypassed this switch will be closed.

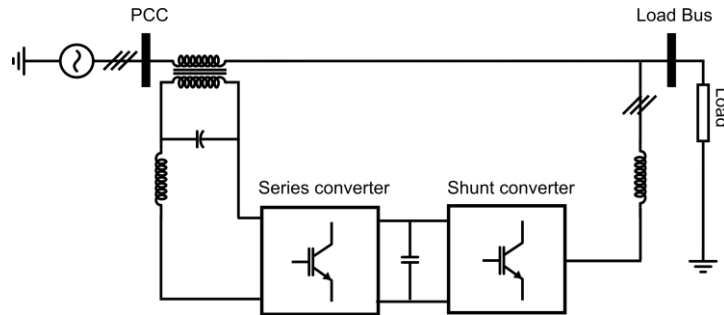

Figure 1: Structure of DVR

The series converter can maintain the ac terminal voltages of the shunt converter at a nominal voltage even while voltage sags occur. Thus shunt converter operation is not affected by distribution feeder disturbances. Therefore, the aim of the dc capacitor is not to store the energy required for riding through voltage sags but to smooth the dc voltage. This makes DC bus capacitance requirement less when compared to the configuration of connecting shunt converter to the uncompensated grid side. The energy required to ride through voltage sag is injected by the series injection transformer. This energy is taken from the grid by the shunt converter and is taken from the feeder itself. Sudden change in energy drawn from the shunt converter occurs during two conditions:

- i) During sag/ swell occurrences when power is compensated by series converter
- ii) During sudden load changes

During these conditions the increased line current may cause an impact upon DC link voltage. The line current flows through the primary of the injection transformer. This will increase the DVR converter current which in turn increases the DC current drawn from the DC link capacitors. The impact of these sudden fluctuations in DC link voltage is minimized by feed forwarding the active current component to shunt converter control algorithm.

### III. Active front end power circuit and control algorithm

This section analyses the shunt converter operation. The shunt converter is an Active front end which maintains the DC bus as a constant during sudden load changes as well as sag/swell conditions. For simplicity consider a single phase front end converter connected to grid using a synchronous impedance. Consider the power circuit of shunt converter shown in Figure 2.

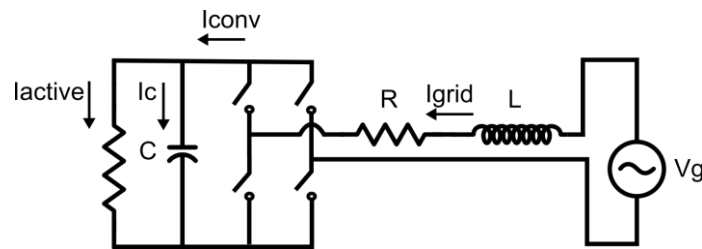

Figure 2: Power Circuit of Active front End

For the analysis the following assumptions, which have only far influence in system dynamics, are made.

1. Transportation delay in sensors, ADCs and in code running time are neglected
2. System sampling is neglected (System is assumed to be continuous system)
3. Switching device is assumed to be ideal (zero turn on and turn off time)
4. Inverter is assumed ideal i.e. inverter ( $V_{conv}$ ) can be replaced by a voltage source whose output is a scaled version of modulating signal

From these, the dynamic equations of power circuit in s-domain can be derived as,

$$i_{grid}(s) = \frac{V_{conv}(s) - V_g(s)}{R + sL} \quad (1)$$

$$i_{conv} = -i_{grid} * \lambda_m \quad (2)$$

$$V_{dc}(s) = \frac{i_{conv}(s) - i_{active}(s)}{Cs} \quad (3)$$

where,  $V_{conv}$  is the inverter output voltage,  $\lambda_m$  is the modulating signal and the other terms are as shown in the figure.

The multi-loop control structure for the shunt converter regulates the dc bus voltage to the fixed Dc reference voltage. In the control scheme, the inverter current, capacitor voltage are sensed as feedback variables and the control algorithm evaluates the necessary switching pulse widths for the a. c- d. c front end rectifier in every sampling interval. The controller block diagram is given in Figure 3.

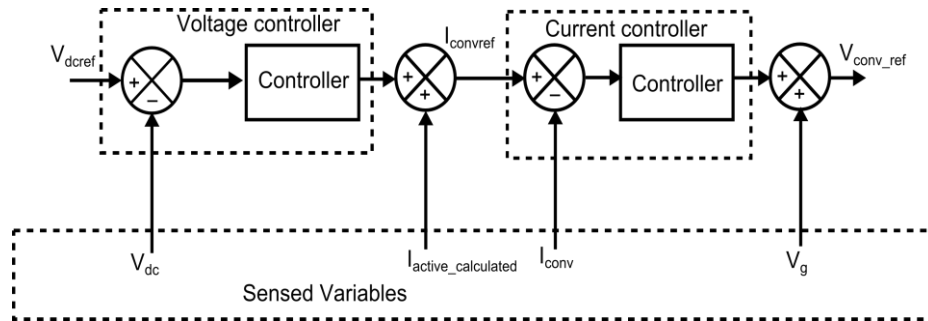

Figure 3: Control algorithm for active front end converter

An inner synchronous inductor current feedback loop is shown embedded within an outer dc bus capacitor voltage feedback loop. Both the voltage and current controllers are implemented in the synchronous reference frame for the three phase converter. For simplicity a single phase front end and its converter are explained in the paper. System transfer function for both the controllers is derived by augmenting the power circuit given in Figure 2 and the control algorithm given in Figure 3. Table 1 gives values selected for the constants given in the power circuit and the controller block diagram.

Table 1. Parameters of shunt controller

Constants	Value
C	3900 $\mu$ F*6
L	1mH
R	0.047 $\Omega$
$\tau_v$	30ms
$\tau_i$	125 $\mu$ s
$K_{PV}$	$C/\tau_v$
$K_{IV}$	$R/\tau_v$
$K_{PI}$	$L/\tau_i$
$K_{II}$	$R/\tau_i$

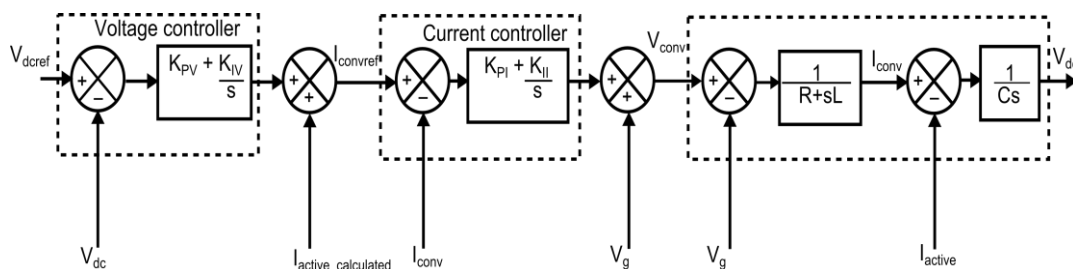

Figure 4: Controller block diagram with power circuit dynamics

The following assumptions are used to simplify the block diagram in Figure 4 to obtain the system transfer function.

1. The grid voltage feed-forward term,  $V_g$ , added at the end of controller block will be cancelled by the grid voltage feedback term present in the power circuit
  2.  $V_{dcref}$  is essentially a constant and doesn't involve in any dynamics. This term can be set to zero
- Considering the above assumptions the complete system block diagram can be reduced as shown below.

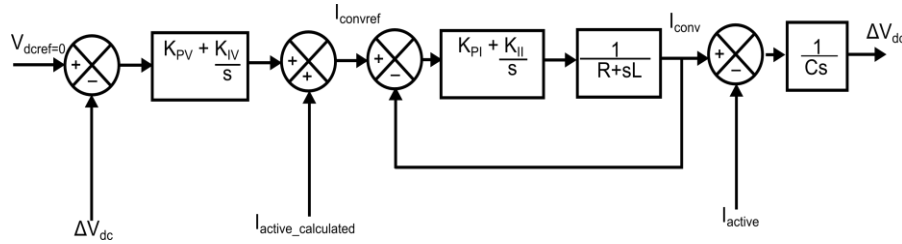

Figure 5: Block diagram without grid voltage term

The inner current controller block shown in Figure 5, can be simplified using the controller constant values from table1. On substituting the current controller values the current loop gets simplified as  $1/(\tau_i s + 1)$ .

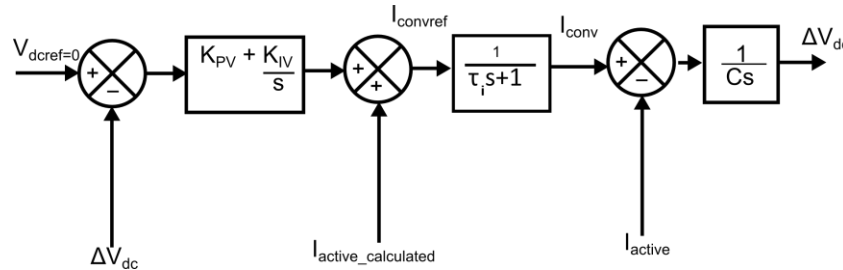

Figure 6: Controller block diagram with reduced current loop

From the above block diagram it is clear that when an active current feed forward is used the converter current reference increases by this amount immediately after the current controller delay and hence there won't be much variation in DC link voltage. Our interest here is to find the change in dc voltage with the change in active current drawn from the front end, when the control algorithm is not augmented with the active current feed-forward term. Hence the block diagram is rearranged to get  $\Delta V_{dc}$  as output and  $I_{active}$  as input. The system transfer function is found out using this simplified block diagram.

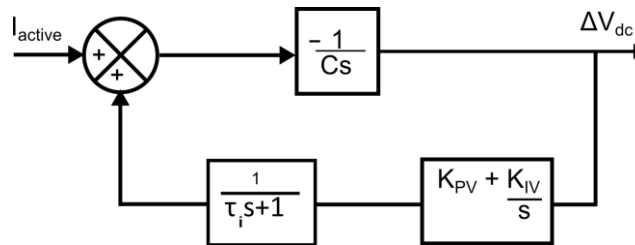

Figure 7: Simplified block diagram

From this reduced block diagram the transfer function change in dc voltage to change in active current can be written as:

$$\frac{\Delta V_{dc}(s)}{I_{active}(s)} = \frac{-\tau_v \tau_i s^2 - \tau_v s}{C \tau_v \tau_i s^3 + C \tau_v s^2 + Cs + R}$$

The third order term has little effect on the response and hence is eliminated in the further analysis. The transfer function can be simplified as below.

$$\frac{\Delta V_{dc}(s)}{I_{active}(s)} = \frac{-s(\tau_i s + 1)}{Cs^2 + k_{PV}s + k_{IV}} \tag{4}$$

where,  $k_{PV}$  and  $k_{IV}$  are proportional and integral constants for voltage controller and  $\tau_i$  is the time constant of current controller. The transfer function given in equation (4) is excited with a step change in active current. This when added with the steady state dc voltage gives the actual capacitor voltage which is found to be matching with the system performance. From the transfer function it is clear that the dc link voltage variation can be minimized by increasing three factors:

- 1) DC bus capacitance
- 2) The proportional constant for voltage controller
- 3) The integral controller for voltage controller

The transfer function can be used for design and analysis of the approximate second order system that is an equivalent of the front end converter. Using the transfer function an stable, over-damped second order system can be designed.

From the transfer function the second order system natural frequency can be found as  $\omega_n = \sqrt{\frac{K_i}{C}}$  and damping

factor,  $\delta = \frac{K_{PV}}{2\sqrt{K_{IV}C}} = 2.037$ . Hence the system is an over damped second order system with two real and unequal

roots. From the transfer function, the change in dc voltage can be written as

$$\Delta V_{dc}(s) = \frac{I_{active}(s)}{C} \frac{-s(\tau_i s + 1)}{(s^2 + \frac{k_{PV}}{C}s + \frac{k_{IV}}{C})}$$

The block diagram given in fig. 4 is excited using a dc voltage reference of 400V and an active current equal to its nominal rating is drawn from it. The figure below shows the system response for sudden change in active current if the dc voltage feed-forward is not added in the control algorithm.

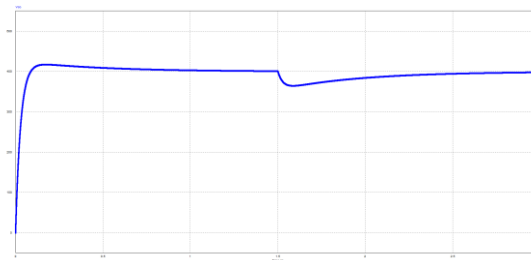

**Figure 8:** Response of Front End without active current feed-forward

The figure below shows the system response for sudden change in active current if the dc voltage feed-forward added in the control algorithm. This clearly shows that the active current feed forward minimizes the effect of sudden change in load as well as sag/swell on the Dc bus voltage.

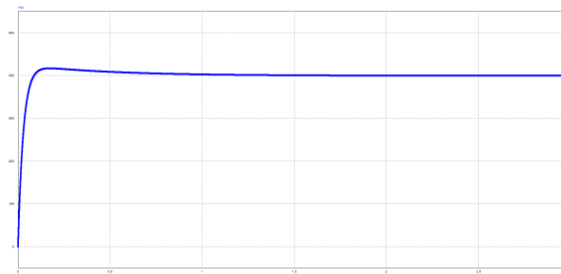

**Figure 9:** Response of Front End with active current feed-forward

The economy in design and the compactness in the power circuit can be further understood when we analyse the circuit further without a feed forward but by increasing the DC bus capacitance to attain the same response as with the feed- forward. The following figure shows a DC bus which is 10 times that is used in our system. It has a steady Dc but the system will become bulky and costly.

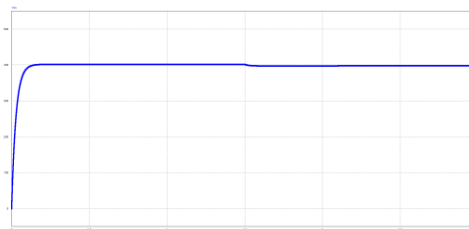

**Figure 8:** Response of Front End with increasing DC bus capacitance

The response of transfer function derived is also analyzed by exciting it with an active current to get the change in DC voltage. It is seen that the  $\Delta V_{DC}$  obtained as response of transfer function is same as the change in DC voltage occurring in the system.

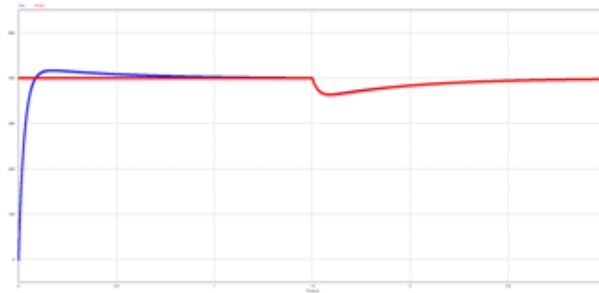

Figure 9: Response of Front End and response of transfer function

#### IV. Experimental Results

The experiments were conducted at NaMPET laboratory, CDAC-Trivandrum. The results are obtained using a 10kVA DVR unit. Fig. 10 shows the dc bus capacitor voltage. It is clear from figure that system follows the response similar to the simulated response. Fig. 11-12 shows the capacitor voltage for sudden switch on and off of load.

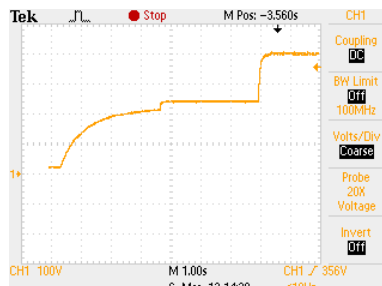

Figure 10: DC bus capacitor voltage

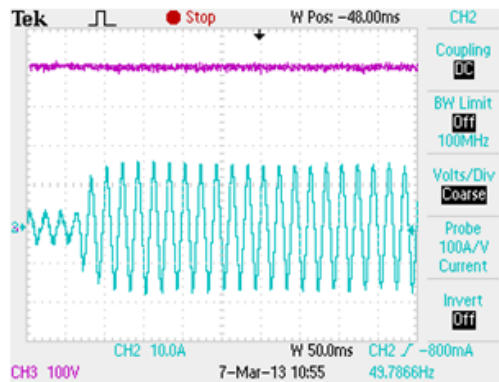

Figure 11: DC bus capacitor voltage and load current for sudden s/w on of load

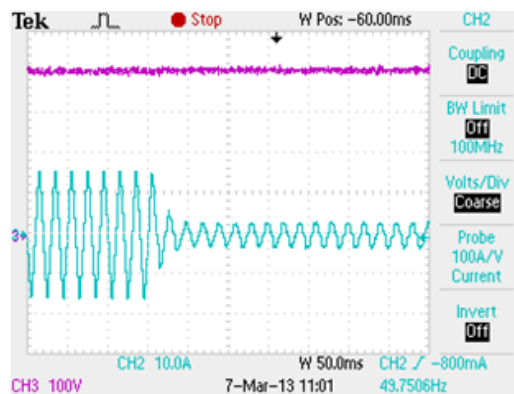

Figure 12: DC bus capacitor voltage and load current for sudden s/w off of load

## V. Conclusion

In Dynamic Voltage Restorer application transient response is of critical importance as events like sag/swell occur for a very short duration. As energy during sag/swell is drawn from DC bus capacitor, the voltage across it must remain steady for the injected voltage to meet its reference voltage. Sudden change in DC bus voltage is avoided in this work by using an active current feed forward. From the transfer function analysis it is clear that this will enable the active current to be compensated within microseconds, hence the DC bus capacitor remains unaffected. The DVR is tested with the proposed controller and the conclusions of analysis are experimentally validated. The performance of DVR is verified for various conditions of voltage sag and swell as well as sudden switching on and off of load.

## References

### Journal Papers:

- [1] N. H. Woodley, L. Morgan, and A. Sundaram, "Experience with an inverter based dynamic voltage restorer," IEEE Trans. Power Del., vol. 14, no. 3, pp. 1181–1186, Jul 1999.
- [2] R. Teodorescu and F. Blaabjerg, "Proportional-resonant controllers. A new breed of controllers suitable for grid-connected voltage-source converters," in Proc. of OPTIM'04, vol. 3, 2004, pp. 9–14.
- [3] Sunil Kumar Gupta, Tiwari.H.P, Ramesh Pachar, "Study of Major Issues and Their Impact on DVR System Performance" International Journal of Computer and Electrical Engineering, Vol. 2, No. 1, February, 2010, pp. 1793-8163.
- [4] Y. Komatsu, T. Kawabata, "Experimental Comparison of pq and Extension pq method for Active Power Filter," EPE 1997, pp.2.729-2.734.
- [5] S. Bhattacharya, D.M. Divan, B. Banerjee, "Synchronous Frame Harmonics Isolator using Active Series Filter," EPE 1991, pp.3.030-3.035.
- [6] V. Soares, P. Verdelho, G.D. Marques, "A control method for active power filter under unbalanced sinusoidal conditions," Power Electronics and variable speed drives PEVD 1996, pp.120-124.
- [7] D. N. Zmood, and D. G. Holmes, "Stationary Frame Current Regulation of PWM Inverters with Zero steady State Error," IEEE Trans. Power Electron., vol. 18, no. 3, pp. 814–822, May 2003.
- [8] H. B. Shin, "New anti-windup PI controller for variable speed motor drives," IEEE tras. on Industrial Electronics, Vol. 45, No. 3, Page(s) 445 - 450, June 1998.